



上海外国语大学
SHANGHAI INTERNATIONAL STUDIES UNIVERSITY

New Media Data Analytics and Application

Lecture 5: System Design and Project Management

Ting Wang

- System Structure Design
- Testing
- Project Progress Management
- Team Management





上海外国语大学

SHANGHAI INTERNATIONAL STUDIES UNIVERSITY

links from the world to the systems

System Structure Design

System Structure Design

A Review: Water Fall Model

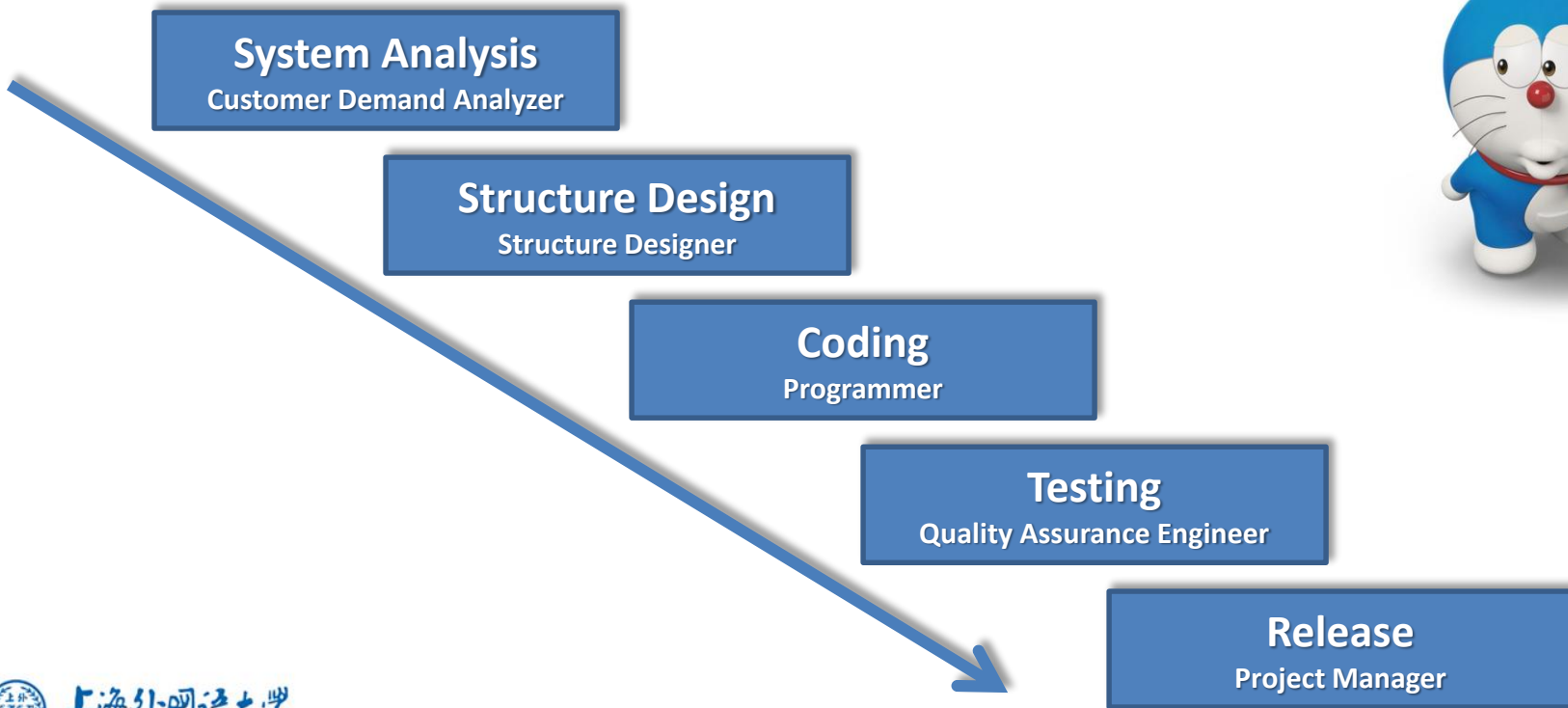

System Structure Design

Two Sub-stages:

1. Overall Design **总体设计**
General Design 概要设计
2. Detailed Design **详细设计**



System Structure Design

Why Overall Design?

Idealized and actual failure curves for software

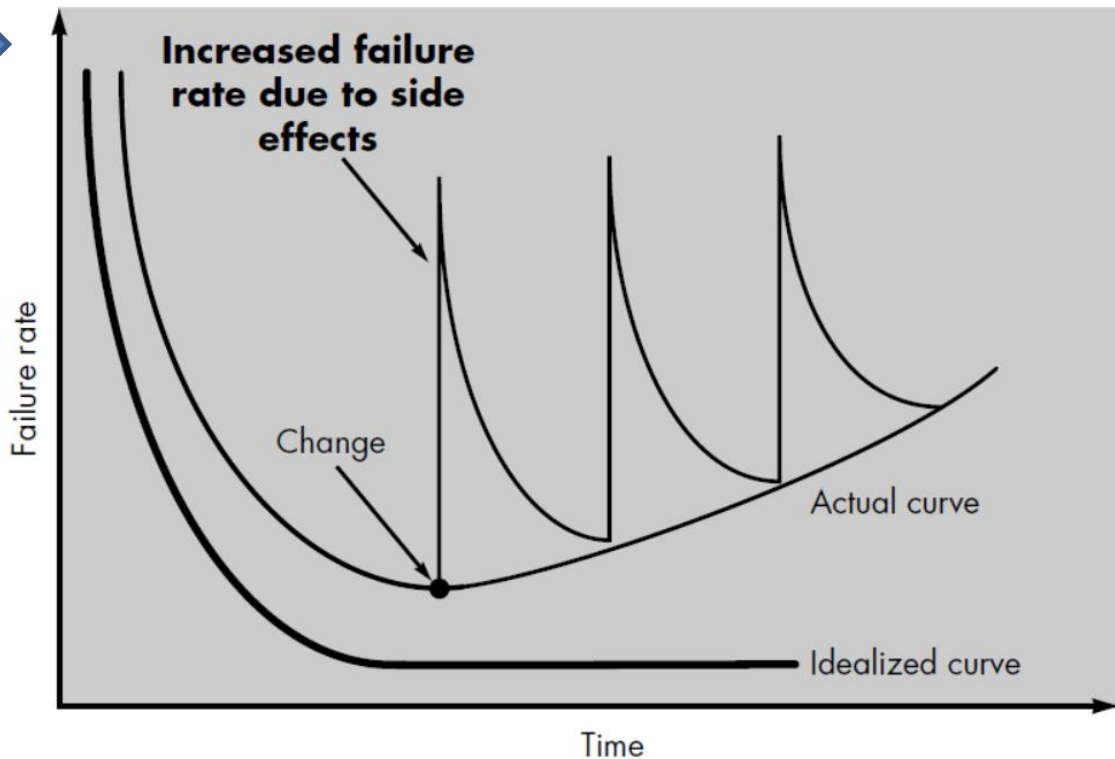

System Structure Design

Cost Change

How to Cost Down?!

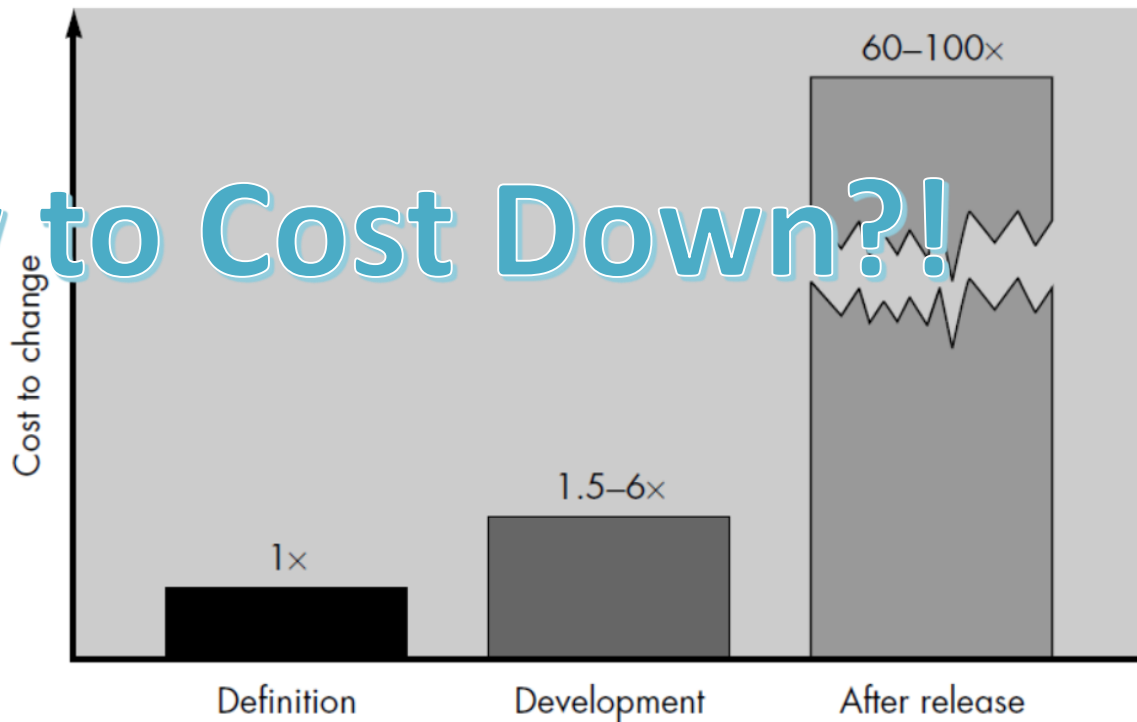

System Structure Design

Overall Design

- Overall Design aims to propose an optimal project plan for software products, which can reduce the cost and enhance the quality.



System Structure Design

Overall Design

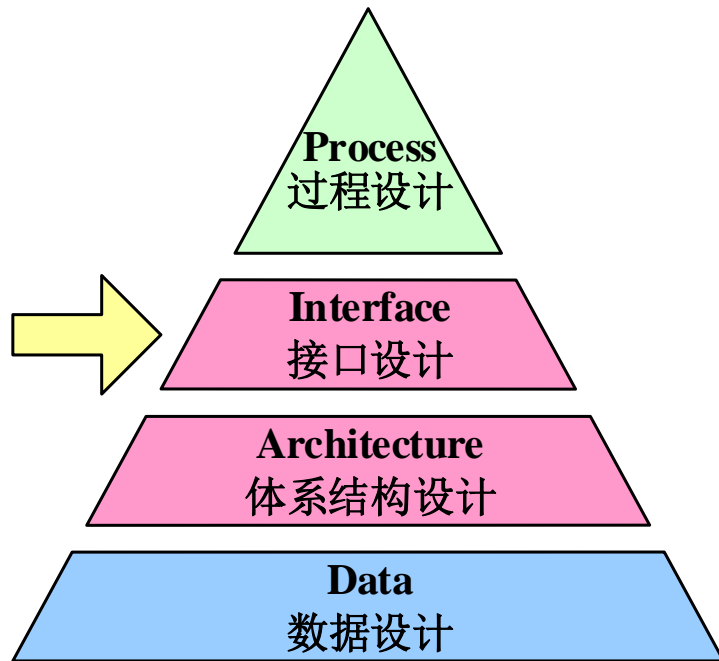
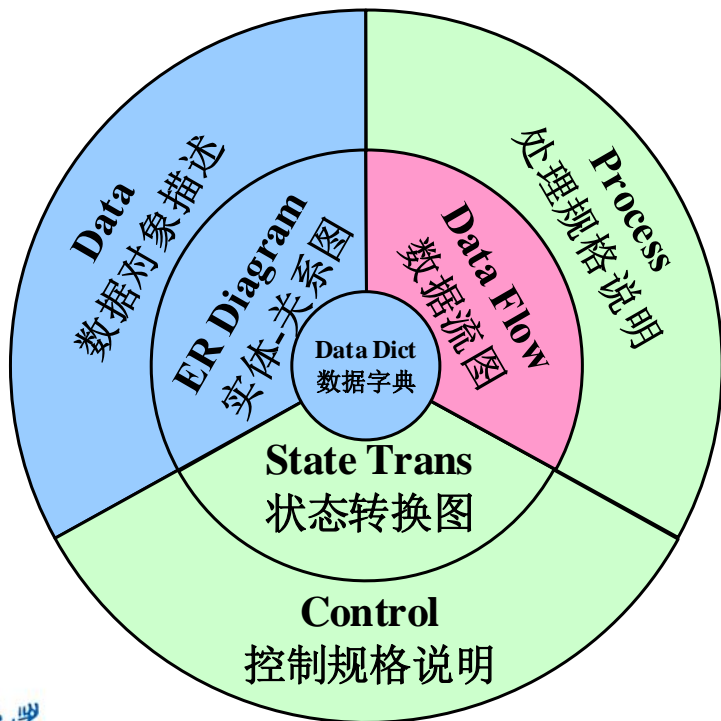

System Structure Design

Steps to Overall Design

1. To list all potential plans for the system
2. To select some feasible plans
3. To select the optimal one
4. To define the functional components

Business
Flow

Component Tree



System Structure Design

Business Flow

Review:

UML: Activity Diagram

Other Corresponding Diagrams in Visio:

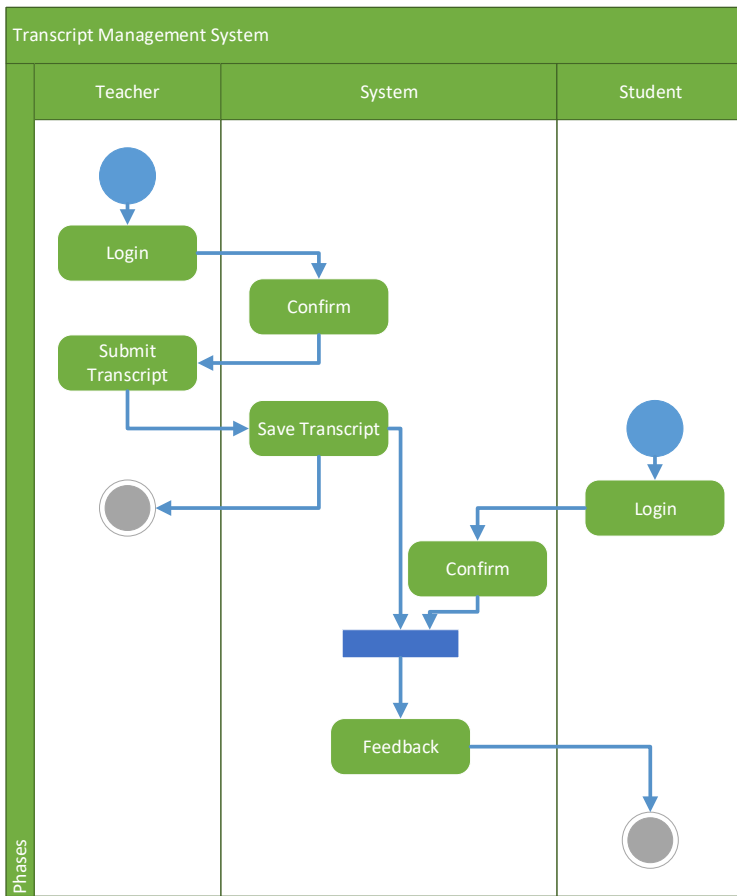

System Structure Design

Component Tree

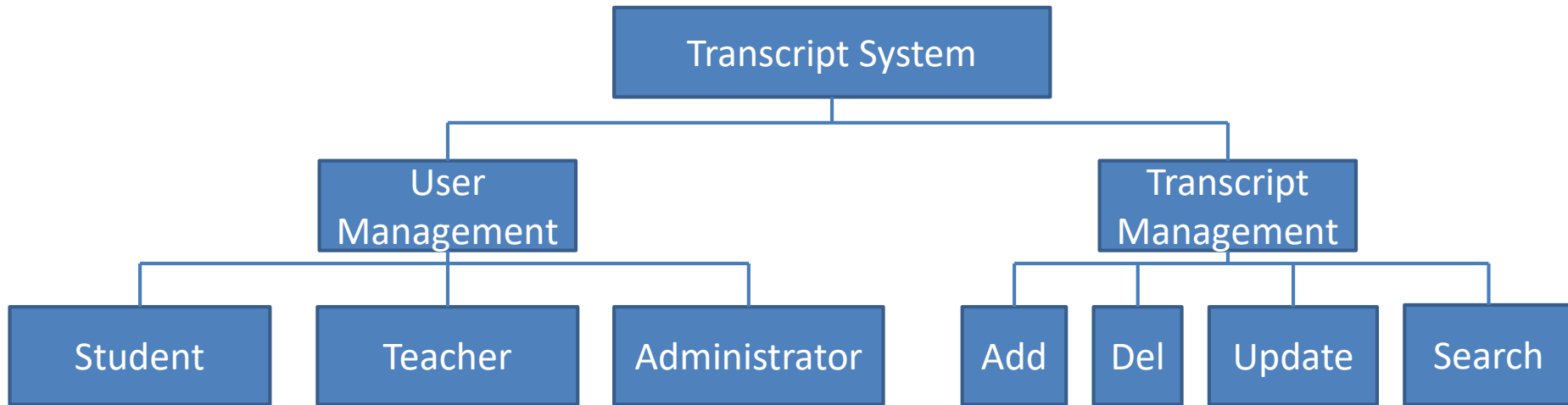

System Structure Design

Detailed Design

Detailed Design aims to divide each function to different subsystems, and decide the corresponding algorithms for each function.



System Structure Design

Steps to Detailed Design

1. To design the system → Interface, Use Case, Data Flow, Sequence
2. To design the data bases → ER Diagram, Database Doc
3. To make the testing plan → Test Plan Doc
4. To write the progress reports
5. Review



System Structure Design

Interface and Prototype Design

- **Axure RP Pro** is a wireframing, rapid prototyping, documentation and specification software tool aimed at web and desktop applications.
- **References**
<https://www.axure.com/>
<https://www.axure.com.cn/>
- **Download**
<https://www.axure.com/download>



System Structure Design

Review: Use Case Diagram

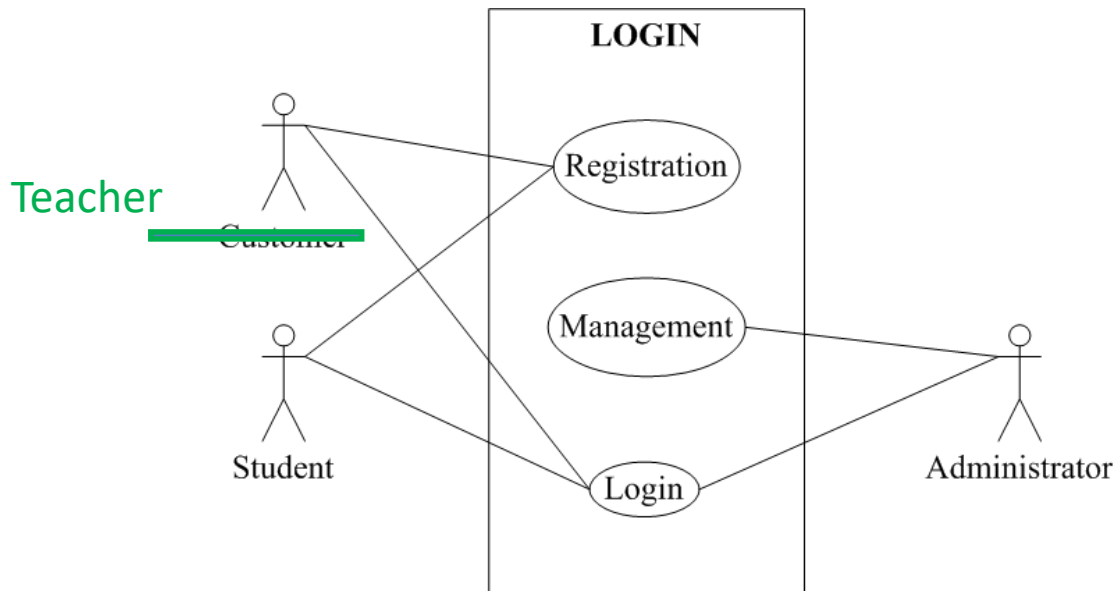

System Structure Design

Review: Sequence Diagram

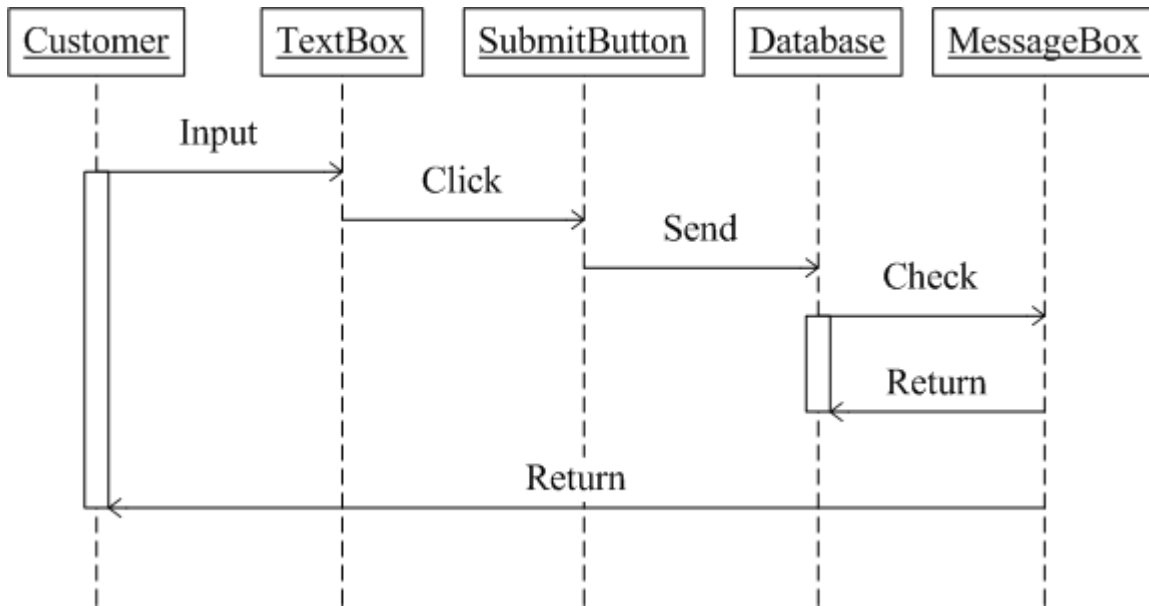

System Structure Design

Data Flow for Algorithms

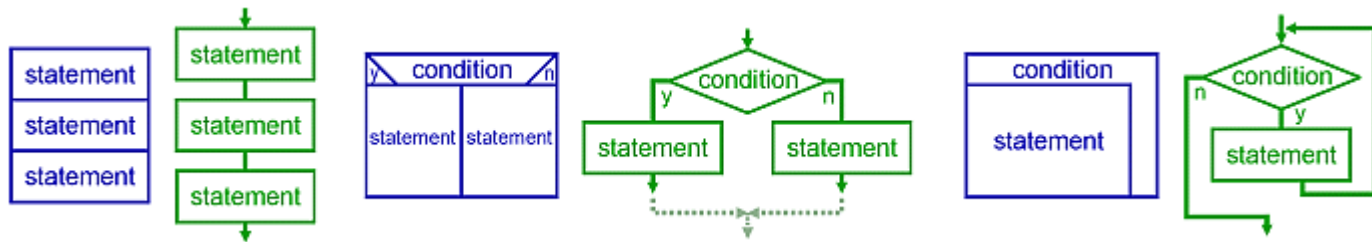

Reuse

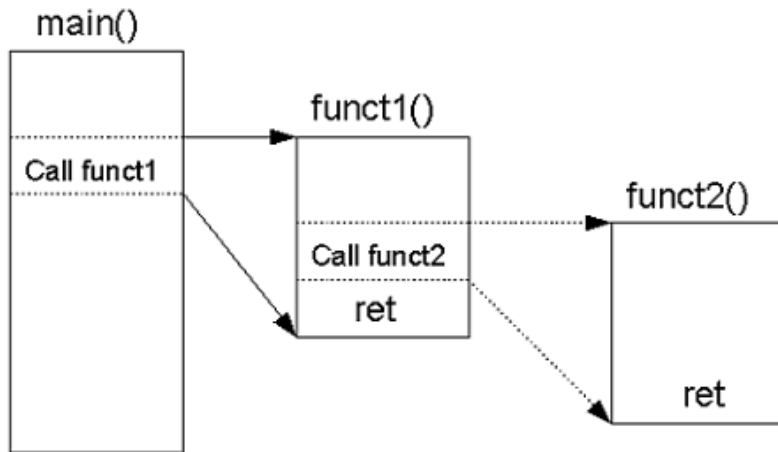

System Structure Design

Example of Data Flow

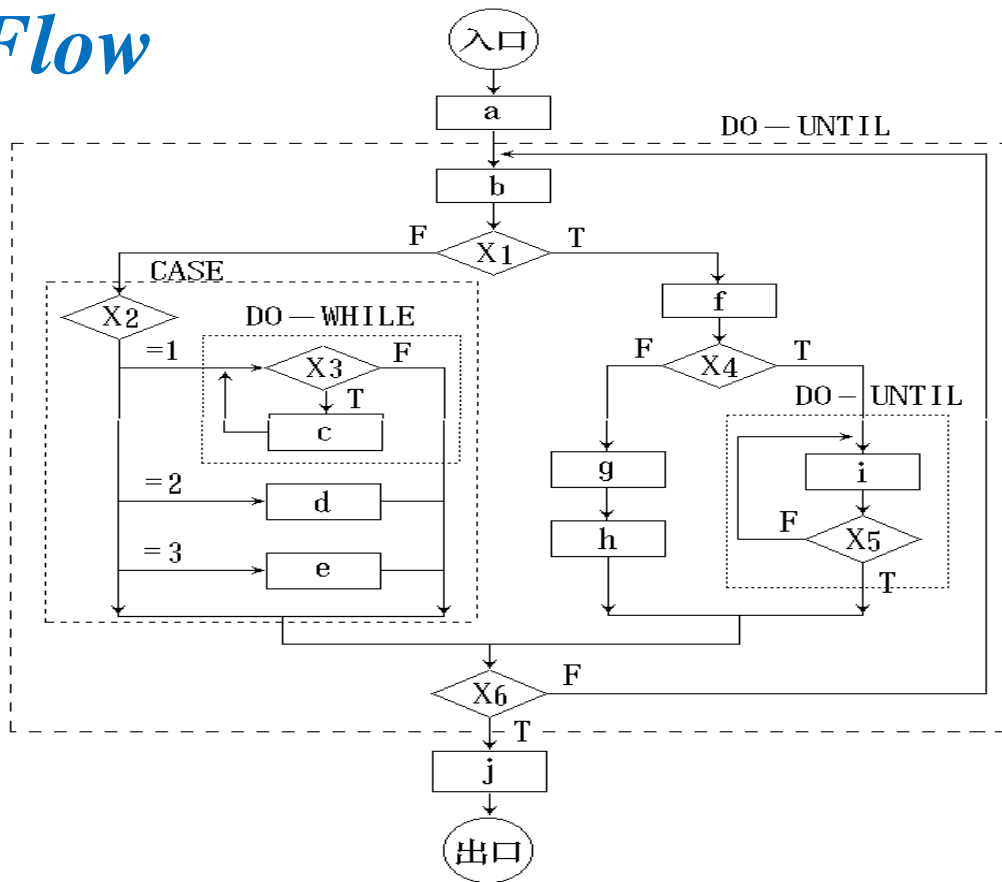

System Structure Design

Pseudo-code for Algorithm Description

- **BSF**

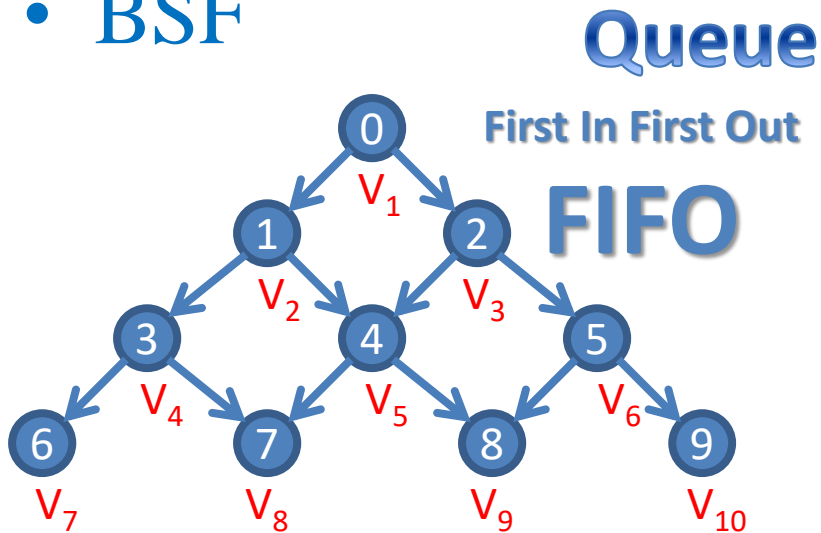

Algorithm Breadth-First Search (BFS)

Require: Initial node v , graph/tree $G(V; E)$, queue Q

1: return An ordering on how nodes are visited

2: Enqueue v into queue Q ;

3: $visitOrder = 0$;

4: while Q not empty do

5: $node = dequeue$ from Q ;

6: if node not visited then

7: $visitOrder = visitOrder + 1$;

8: Mark node as visited with order $visitOrder$;
 //or print node

9: Enqueue all neighbors/children of node into Q ;

10: end if

11: end while



System Structure Design

Review: ER Diagram

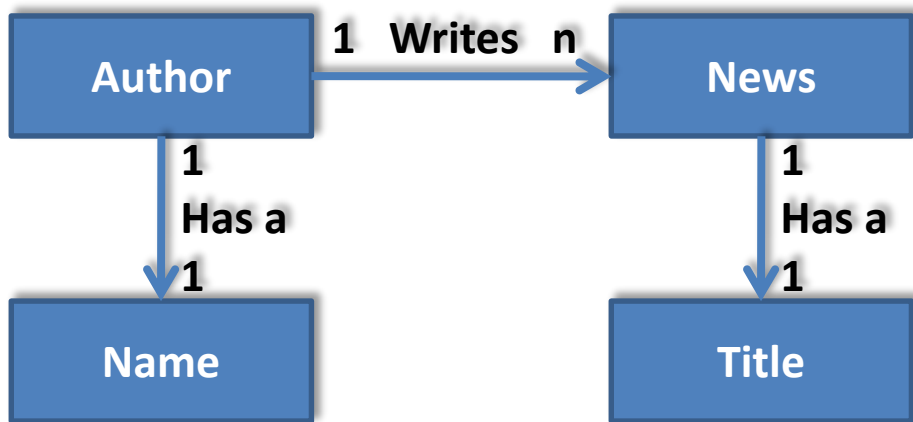

System Structure Design

Database Document



档案名称。	SYS_ADMIN_MESSAGE。					
档案用途。	管理留言资料档。					
主键(PK)。	SYS_ADMIN_MESSAGE_PK: MESSAGE_ID(Cluster Index)。					
附键(AK)。	。					
	INDEX NAME。	栏位。	用途。			
	SYS_ADMIN_MESSAGE_FK1。	MESSAGE_FROM。	FK: ADMIN_INFO(ADMIN_ID)。			
	SYS_ADMIN_MESSAGE_FK2。	MESSAGE_TO。	FK: ADMIN_INFO(ADMIN_ID)。			
序号	栏位名称。	栏位说明。	资料形态。	长度。	Null。	Default。
01	MESSAGE_ID。	留言编号。	Number。	。	X。	。
02	MESSAGE_NAME。	留言标题。	Char。	200。	X。	。
03	MESSAGE_INFO。	留言内容。	Text。	。	。	。
04	MESSAGE_TO。	收音人员编号。	Number。	。	X。	。
05	READ_FLAG。	已读标识。	Number。	。	X。	0。
06	STATE。	状态。	Number。	。	X。	0。
06	CREATE_USER_ID。	创建人编号。	Number。	。	X。	1。
07	CREATE_DATE。	创建日期。	Date。	。	X。	。
08	UPDATE_DATE。	更新日期。	Date。	。	X。	。

[注:] 已读标识: 0-未读, 1-已读, 2-已删, 3为彻底删除。

状态: 0-正常, 1-已删除, 2为彻底删除。



System Structure Design

Principles:

1. Abstraction 抽象
2. Information Hiding and Localization
信息隐藏与局部化
3. Modularity 模块化
4. Refinement 自顶向下，逐步求精



System Structure Design

Abstraction 抽象

1. Extract the same parts from different things

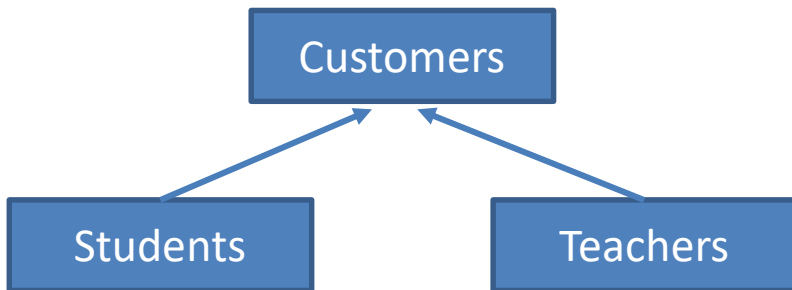

2. Give levels to analyze them



Grady Booch
IBM Fellow

“Abstraction is one of the fundamental ways that we as humans cope with complexity.”

— Grady Booch



Information Hiding and Localization

信息隐藏与局部化

- Modules should be specified and designed so that information contained within a module is inaccessible to other modules that have no need for such information.



Modularity 模块化

1. Divide and Conquer
2. Software architecture is divided into components called modules.

- *Low Coupling, High Cohesion*
低耦合，高内聚



Refinement

自顶向下，逐步求精

- It is the process of elaboration. A hierarchy is developed by decomposing a macroscopic statement of function in a step-wise fashion until **programming language statements are reached**. In each step, one or several instructions of a given program are decomposed into more detailed instructions. Abstraction and Refinement are complementary concepts.



System Structure Design

Complexity of the Algorithms

- Time Complexity 时间复杂度

```
1 sum = n*(n+1)/2; //时间复杂度O(1)
```

```
1 for(int i = 0; i < n; i++){
2     printf("%d ",i);
3 }
4 //时间复杂度O(n)
```

```
1 for(int i = 0; i < n; i++){
2     for(int j = 0; j < n; j++){
3         printf("%d ",i);
4     }
5 }
6 //时间复杂度O(n^2)
```

```
1 int i = 1, n = 100;
2 while(i < n){
3     i = i * 2;
4 }
5 //设执行次数为x.  $2^x = n$  即  $x = \log_2 n$ 
6 //时间复杂度O(log2n)
```

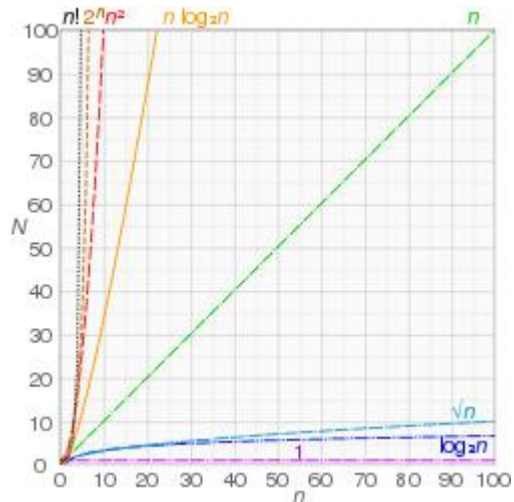

System Structure Design

- Space Complexity 空间复杂度
 - Relevant to Time Complexity
 - Including:
 - Initialized data
 - Algorithm data
 - Some additional data





上海外国语大学
SHANGHAI INTERNATIONAL STUDIES UNIVERSITY

software quality assurance

Testing

A Review: Water Fall Model

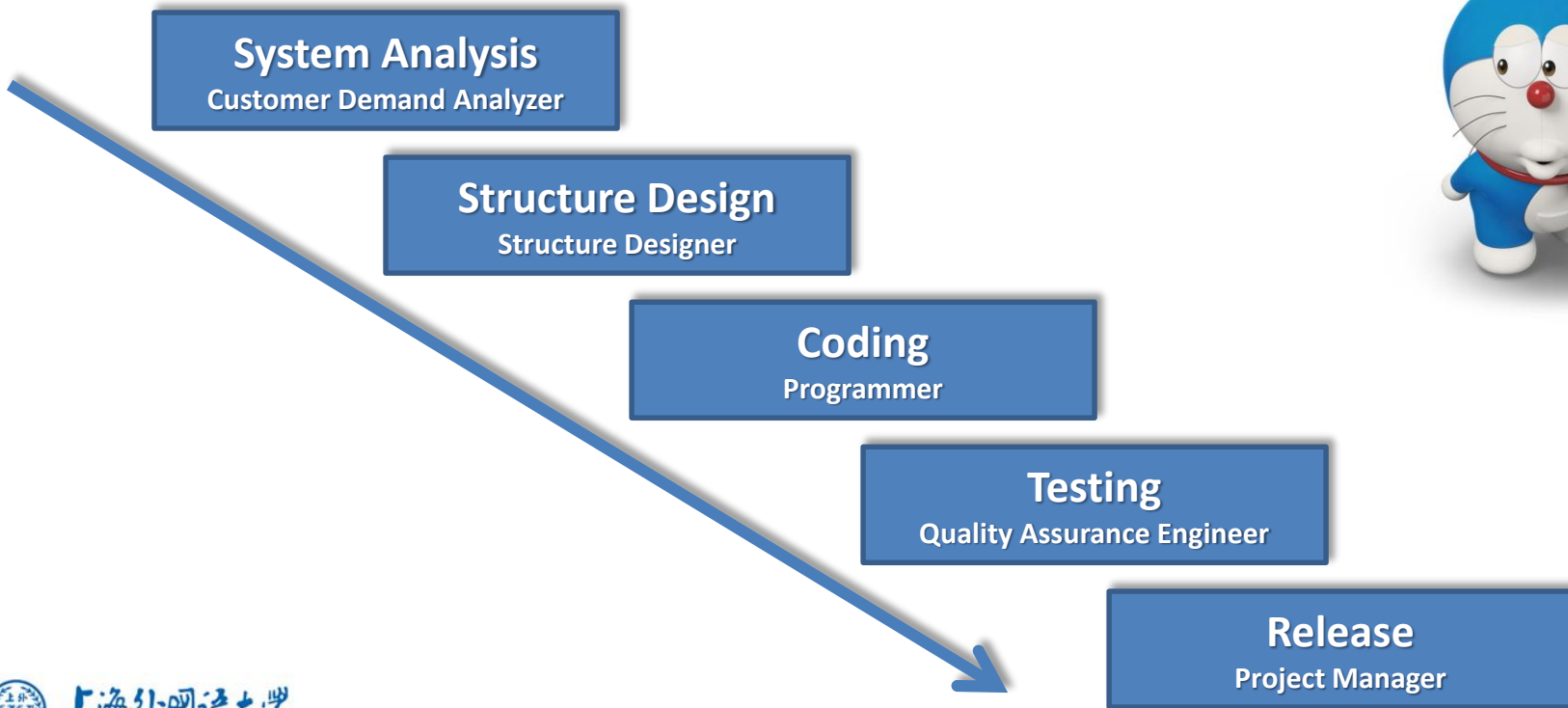

Testing Preparation Stages



Testing Plan

- **Testing Case** is a specification of the inputs, execution conditions, testing procedure, and expected results that define a single test to be executed to achieve a particular software testing objective, such as to exercise a particular program path or to verify compliance with a specific requirement.
- **Automatic Testing Tools**
 - Web: selenium, QTP
 - Function: loadrunner, jmeter
 - Interface: SoapUI, postman
 - Cellphone: robotium, appium



Testing Types and Stages:

1. White Box: Programmer
 2. Black Box: Programmer and Testing Engineer (same group)
 3. Integration Testing: Programmer and Testing Engineer (different groups)
 4. Regression Testing: Programmer and Testing Engineer
 5. Release Testing: Testing Engineer (all groups)
 6. Disaster Recovery Testing : Testing Engineer
 7. Alpha Testing: Testing Engineer (all groups)
 8. Beta Testing: User
- Developing Coding Stages
- Testing Stages

Testing Report

- Introduction
- Testing Results
- Results Analysis
- Conclusions
- Cost and Consumption





finish your project before the deadline

Project Progress Management

Project Progress Management

When you want to start a new project, you should know:

1. When is the deadline;
2. How many people you have;
3. How many components in this projects;
4. Which components can be done in parallel;
5. Risks.



Project Progress Management

How to do:

- To give out the schedule start from the deadline
- To know the advantages of your team members
- To divide the system into components
- To avoid the risks



Project Progress Management

Diagrams

- Gantt chart

Activity	Predecessor	Time estimates			Expected time (T_E)
		Opt. (O)	Normal (M)	Pess. (P)	
<i>a</i>	—	2	4	6	4.00
<i>b</i>	—	3	5	9	5.33
<i>c</i>	<i>a</i>	4	5	7	5.17
<i>d</i>	<i>a</i>	4	6	10	6.33
<i>e</i>	<i>b, c</i>	4	5	7	5.17
<i>f</i>	<i>d</i>	3	4	8	4.50
<i>g</i>	<i>e</i>	3	5	8	5.17

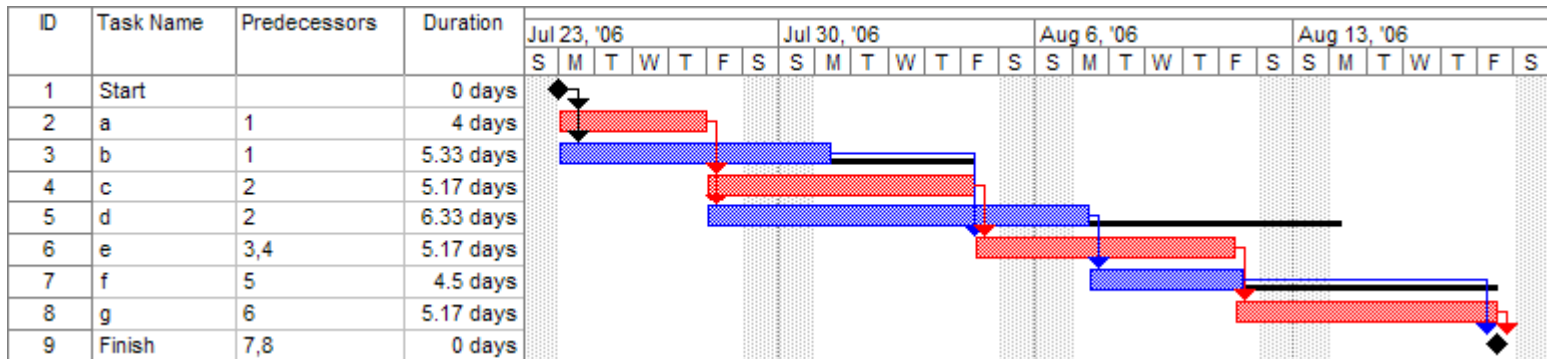

Project Progress Management

Milestone

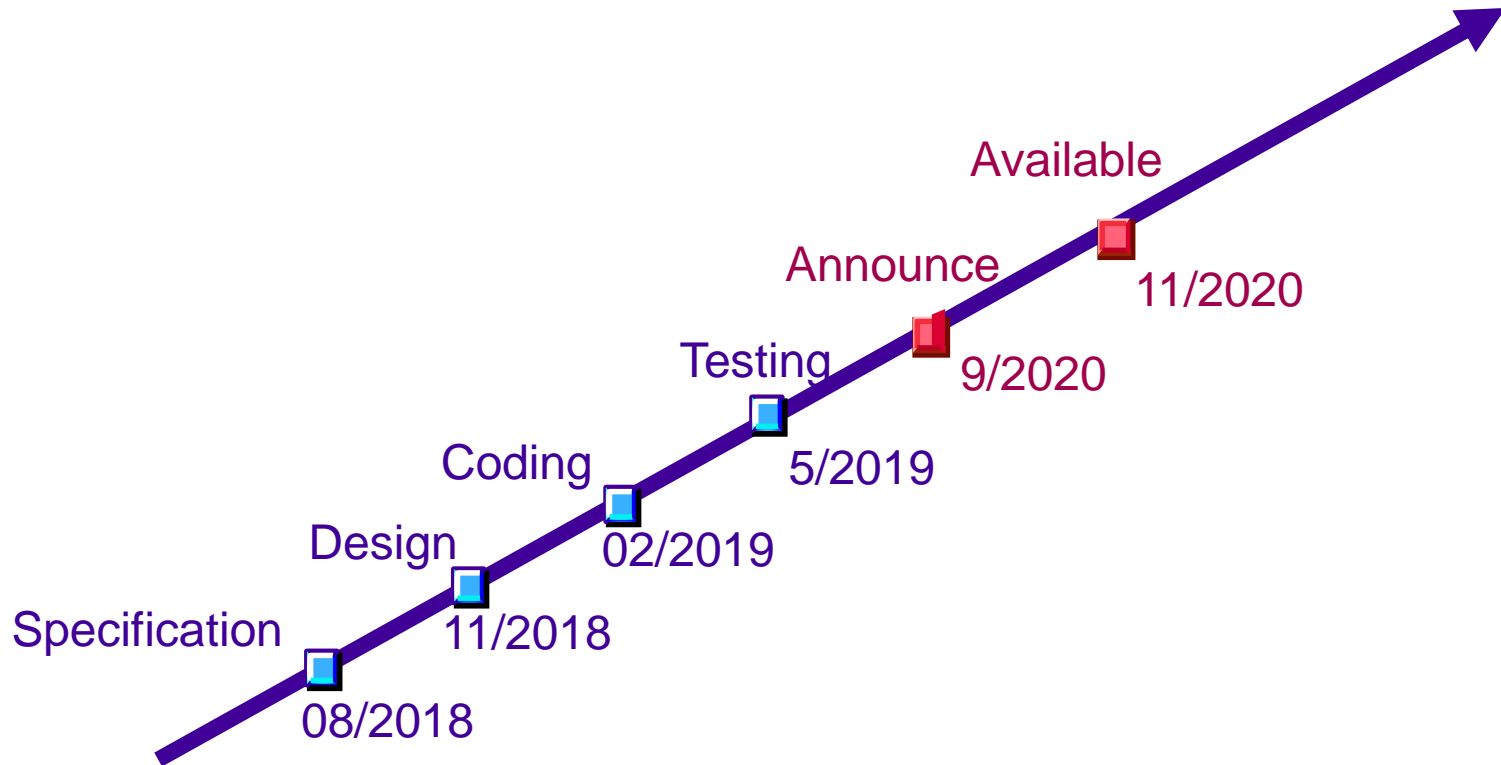

Project Progress Management

Critical Path

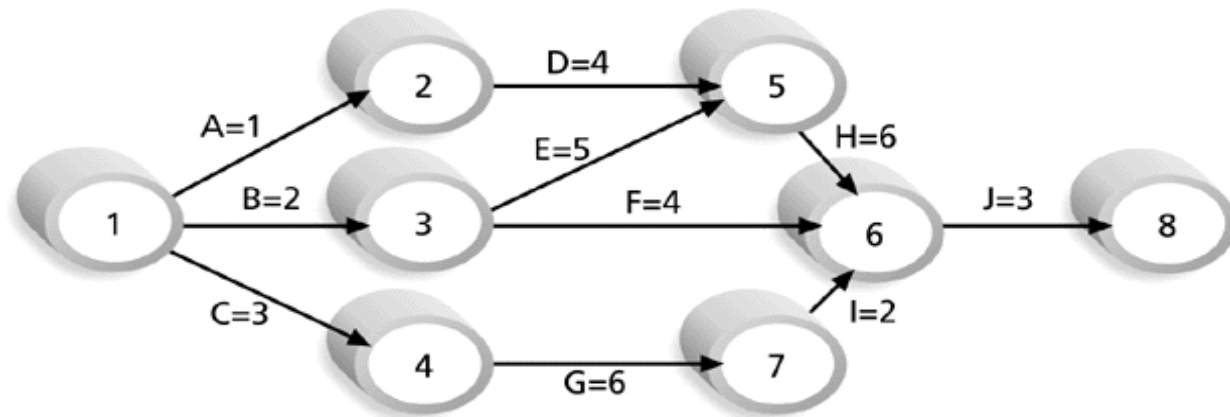

Note: Assume all durations are in days.

Path 1: A-D-H-J Length = $1+4+6+3 = 14$ days

Path 2: B-E-H-J Length = $2+5+6+3 = 16$ days

Path 3: B-F-J Length = $2+4+3 = 9$ days

Path 4: C-G-I-J Length = $3+6+2+3 = 14$ days

Since the critical path is the longest path through the network diagram, Path 2, B-E-H-J, is the critical path for Project X.

Project Progress Management

Resource Consumption

- Human
- Time
- Equipment
- Investment
- ...



Risks



Project Progress Management

One More Important Risks:

- Demand Changing

Demand Confirm is very very very important!

Revision Control

- CVS
- SVN
- Git
- VSS



Project Progress Management

Report:

- 项目开发计划
- 开发进度月报
- 项目开发总结报告





上海外国语大学
SHANGHAI INTERNATIONAL STUDIES UNIVERSITY

a group working method

Team Management

Team Management

Team Member

- Customer
- Your Group
- Vender
- Provider

Project Manager
System Analyzer
System Designer
Database Administrator
Programmer
Testing Engineer
Sales
...



How to run a team ?

- Culture
- Rules
- Good administrative director
- Motivation
- Promotion
- Backup important roles
- Good management of documents and codes



案例题

你是一个项目的项目经理，项目已经接近尾声，项目组一些成员已经分配到其他的项目组中，其中的一个设计人员由于还有一些事情，所以还留在项目继续工作，但是，这个设计人员突然提出来希望离开这个项目，因为另外一个项目需要他做项目经理的工作，他不想失去这个机会，这时作为项目经理，你应该如何做：



- A) 找另外一个合适的人完成剩下的工作，同意他到新的项目中，但是要求做好交接工作，同时要求他参加必要的会议
- B) 要求他不要离开这个项目，因为他是最好的人选
- C) 不管怎样，他必须完成项目的收尾工作
- D) 同意他接手新的项目，但是要求他周末或者晚上的时候负责原来项目的收尾工作



Ways to Influence that Help and Hurt Projects

- Projects are more likely to succeed when project managers influence with
 - expertise
 - work challenge
- Projects are more likely to fail when project managers rely too heavily on
 - authority
 - money
 - penalty



Suggestions for Improving Project Communications

- Manage conflicts effectively
- Develop better communication skills
- Run effective meetings
- Use templates for project communications

Email is always the best!





上海外国语大学
SHANGHAI INTERNATIONAL STUDIES UNIVERSITY

References

Books › Computers & Technology › Programming

Software Engineering: A Practitioner's Approach 8th Edition

by Roger S. Pressman (Author), Bruce Maxim (Author)

★★★★☆ 23 customer reviews

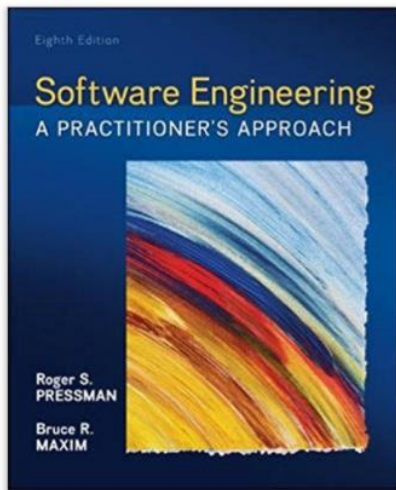

ISBN-13: 978-0078022128

Hardcover

\$30.38 - \$100.88

Paperback

\$43.48

Other Sellers

See all 5 versions

Rent

Buy new

In Stock.

Sold by **TEXTBookAMAZING** and Fulfilled by Amazon.

This item ships to **China**. [Learn more](#)

References

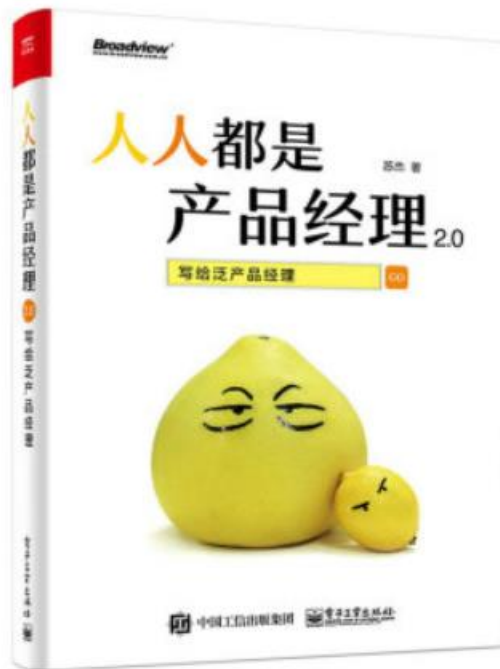
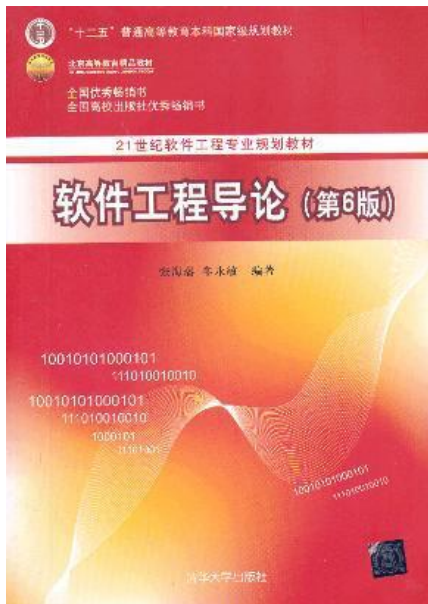



上海外國語大學
SHANGHAI INTERNATIONAL STUDIES UNIVERSITY

Homework

Start your group work and prepare for your presentation on **April 8**, you should choose one of following Topics, and tell us how to do it with your plan:

1. 电影票房预测
2. 影视明星与广告产品的适配度
3. 舆情大数据与社会治理
4. 微信公众号的影响力预测



Homework

Finish the following Documents for your project:

- 数据库设计说明书
- 详细设计说明书
- 项目开发计划
- 测试计划
- 数据要求说明书(Optional)
- 模块开发卷宗(Optional)

Additional Score will be added for optional documents.

Deadline: **April 30.**





The End of Lecture 5

Thank You



<http://www.wangting.ac.cn>